

STANDARD Y-GATE PLAN

FENCES AND WILDLIFE

As our mountain communities continue to burgeon, pushing development into rural areas, we have an increasing responsibility to use the land in an environmentally responsible manner. Almost everything we do affects wildlife and its habitat, either directly or indirectly.

Fences, coupled with the development of roads, loss of habitat, and encroachment of human activity, can contribute significantly to mortality of elk and deer. Fences act as a barrier to daily movement and seasonal migration of free-ranging animals. They often deter young and make them more vulnerable to predation and road kill. A poorly-designed fence may lead to entanglement and eventual mortality, particularly during times of winter stress.

LOW IMPACT FENCES

"Fences have just one mission in life, to fall down". - A Colorado rancher

This brochure provides recommendations by the Colorado Division of Wildlife on how to fence in a manner that will protect property and livestock, while at the same time reducing impacts on wildlife. It offers information on various types of low-impact fencing which will require minimal expense and upkeep. All the information provided has been **field-tested** by real people out in the field, by those who depend on fences to protect their land and livestock. If you build your fences in keeping with the information given here, you will benefit for years to come - with less time and money invested in construction and maintenance - and will have the satisfaction of knowing that your management decisions will not conflict with the environment.

PLANNING YOUR FENCE

In some instances, landowners build a fence for no other reason than because "it's the thing to do". Consider your needs. If you are not in an area that cattle graze, fencing your property may not be necessary; but would only be detrimental to the wildlife and scenery that you and others enjoy. What purpose will your fence serve? And how can you design that fence to meet your needs while at the same time living in a way that is environmentally responsible?

Other than boundaries, where will you want fences? Would temporary fences suit your purposes, or is permanent fencing required? Are there sections of fence that cross known game trails - would a swing-back, adjustable or lay-down section be workable in this area? Consider whether the fence you're planning will separate wildlife from their accustomed water source, food source, fawning/calving ground, or security cover? (If so, realize that increased maintenance time and cost may warrant a careful design.) A 42" high top wire, and/or a 16" bottom wire will hold livestock if fence is kept in good condition.

Thinking through your goals and how you plan to achieve them, along with the consequences of each method. This will help you clarify which fencing option will best fit your operation.

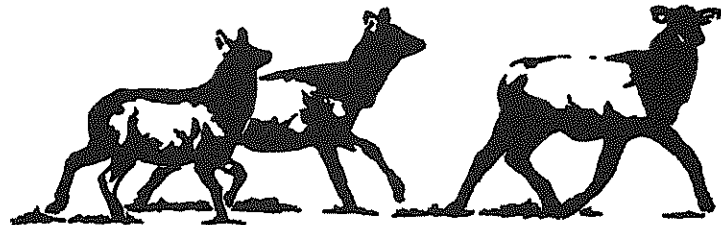

WATER GAP AREAS

With Very Little Water & Only Occasional Flooding

WATER GAP WITH LINE POSTS

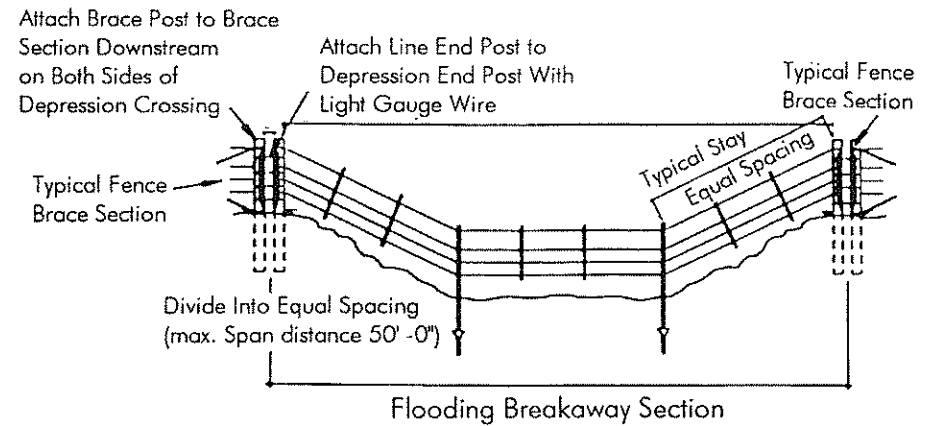

WATER GAP WITH ROCK ANCHORS

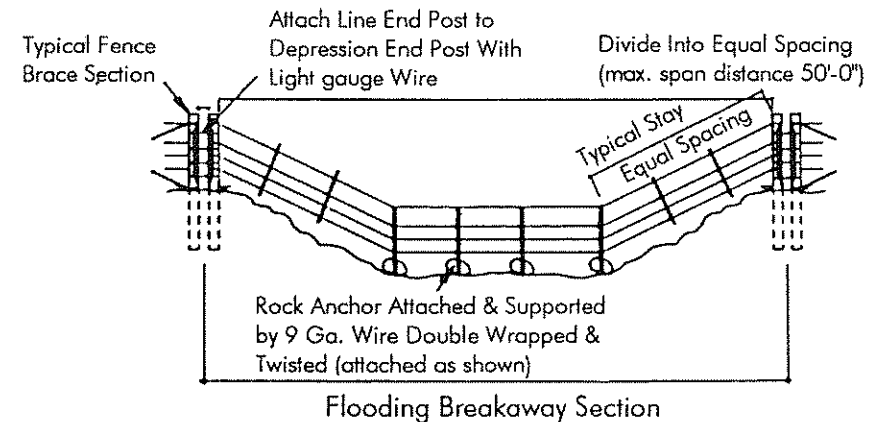

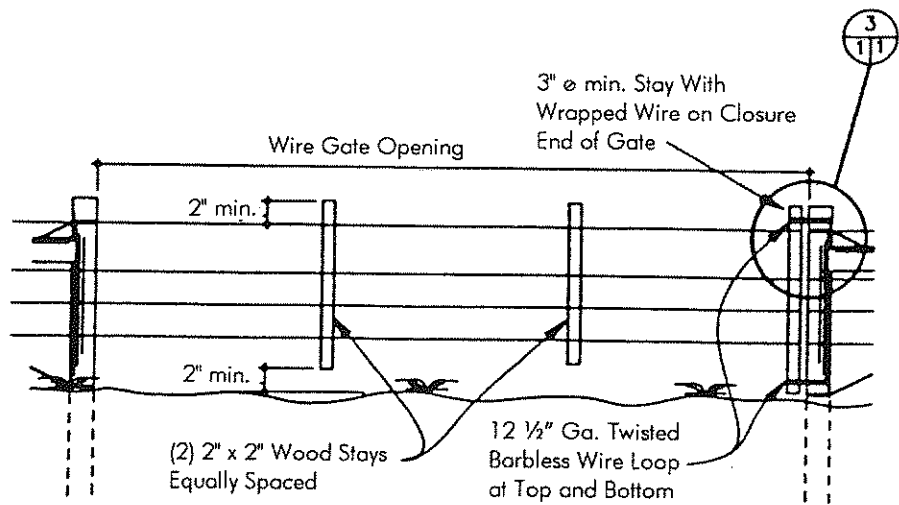

WIRE STRETCH GATE

Please realize that when wildlife encounter a 42" fence on a 50% slope, they have an obstacle 75" high to jump.

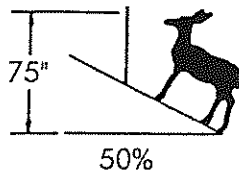
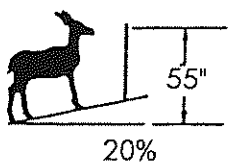
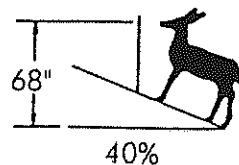
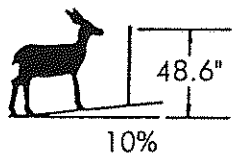
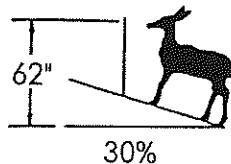
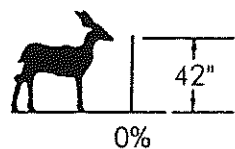

Barrier Height Increase of 42" Fence on Contour of Different Percent Slopes

KEY INGREDIENTS

The key to minimizing hassle is to keep fence wires taut at a height that allows game to cross safely. Often a 16' pole laid horizontally with the top wire, or vinyl ribbon hung on top of the fence in a heavily crossed area will help eliminate costly repairs. With any newly constructed fence, it is important to flag the fence immediately after construction. This will help protect your fence until wildlife and domestic livestock become accustomed to the new barrier.

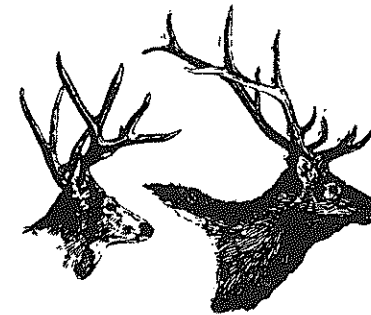

FENCING FOR DEER AND ELK

The height of the fence and spacing of the top two wires are primary considerations in erecting a fence that will allow peaceful coexistence with elk and deer. If you are not keen on having these big animals entangled in your fence, keep the height of the fence under 42 inches with at least 12 inch spacing between the top two wires. (Deer and elk jump with their hind legs forward, so if the top strands are too close together or are loose, they'll often get hung up, resulting in injury or death and a lot of extra fence work for you.)

Keep in mind is the height of lower wires. Young deer and elk tend to go under, rather than over a fence; therefore, height of the lower wire can impede their movement.



FENCING FOR ANTELOPE

Your best bet for permanent fencing is usually three-wire construction, except for stretches where you anticipate heavy pressure from livestock, such as bull pastures on boundaries where a four-strand fence may be necessary. Antelope are likely to seek out sections of fence with the greatest clearance between the ground and bottom wire -- even when that clearance is only a couple of inches higher than the rest. For any fence, a bottom wire at least 16-18 inches off the ground will provide antelope passage under normal conditions. Wherever traditional barbed wire is planned, the bottom wire should be smooth to allow antelope to pass without catching it and pulling down that wire. With electric fences, that bottom wire should be grounded.

TYPICAL ANTELOPE PASS

not to scale

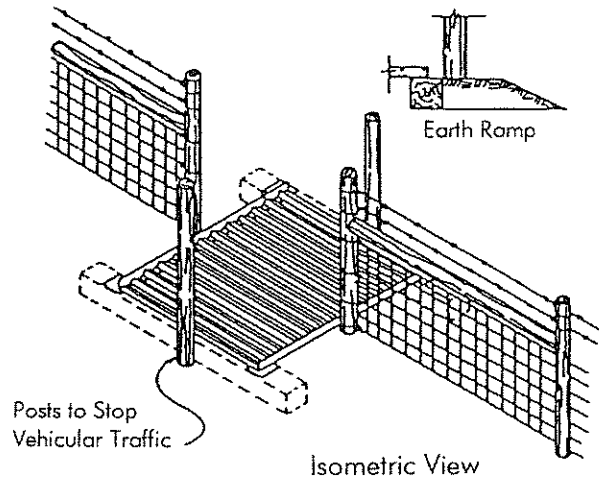

Gates and Passes

Preferred

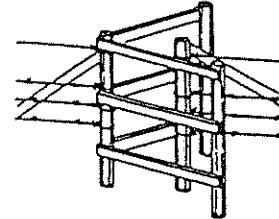

PEDESTRIAN WALK THROUGH Y-GATE

Optional

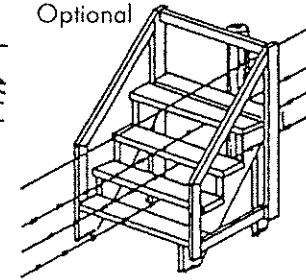

STEP-OVER STILE

Optional

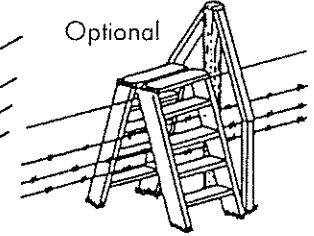

STEP-OVER STILE

Don't Forget the Humans

Aside from removable or sliding gates and fence sections, take into account where you might want to have access for people (especially if you are using public lands). Besides being handy for you, gates and passes that allow easy access for humans will preserve your fence as well as promote goodwill, and that can be worth a lot.

Secured with Drift Pins

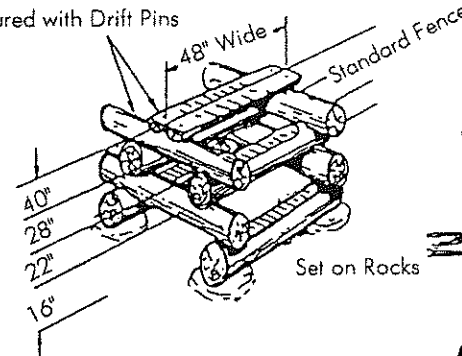

FENCE STILE

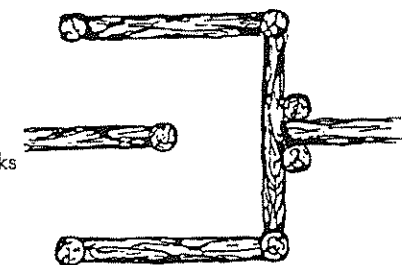

WALK-THROUGH GATE
Excludes Livestock & Wildlife

TYPES OF FENCING

Elk Jumps

These are made of corral poles stacked parallel to the ground to the recommended height of 40-42". Length can vary but shouldn't be shorter than 14'. Depending on the length of the poles, sets of two vertical poles to hold the stack in place should not be less than 12' apart.

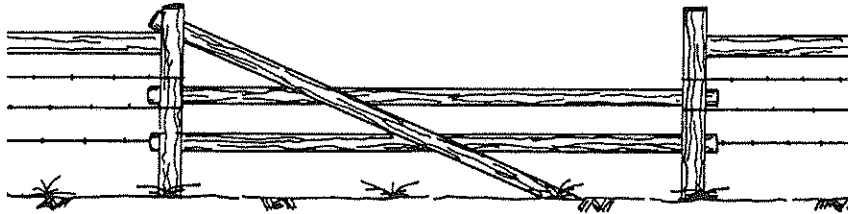

Adjustable and Sliding Gates

Removable fence sections and gates also help mitigate migration blockages. Simply removing sections of fence, or opening strategically located gates will reduce blockages of critical migration routes for elk and deer herds during the winter months. This allows movement between various portions of winter range, providing access to food and shelter.

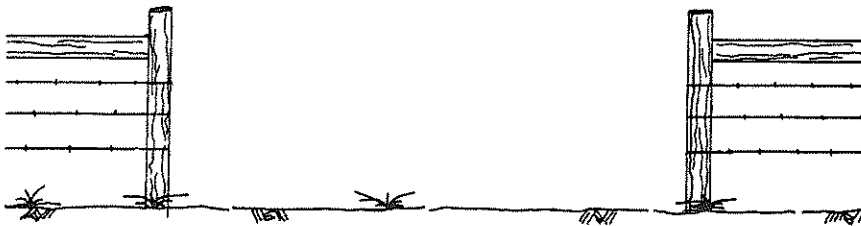

Electric Fence

Using electric fence wherever possible, temporary or permanent, will save time and considerable money. Temporary fencing can alleviate conflict with wildlife while giving you more options in managing your livestock. For specific information on the cost and construction of temporary or permanent electric fencing, contact CSU Extension (970-724-3436) for their detailed report, "Electric fencing for rangelands".

Checklist:

- Signs warning humans of electrical fence hazard.
- Grounded bottom wire at least 16" above the ground.
- At least 12" between top two wires.
- Top wire 40" or lower.
- Flag newly constructed portions of fence.
- Don't use yellow or red insulators, which will attract some birds and may result in electrocution.

ELECTRIC FENCES

not to scale

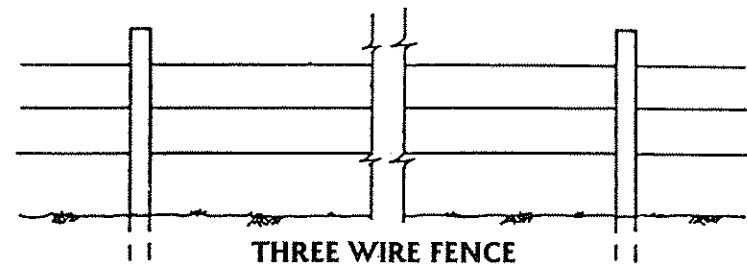
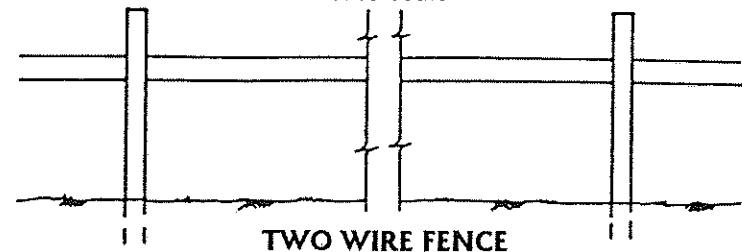

Lay-down fence in snow country.

Where damage from snow is severe on standard wire fences, a lay-down fence has reduced maintenance costs by two-thirds on Black Mesa in western Colorado. Basically it is a standard 4-wire fence that can be laid down as a unit. One person working alone can let it down or put it up.

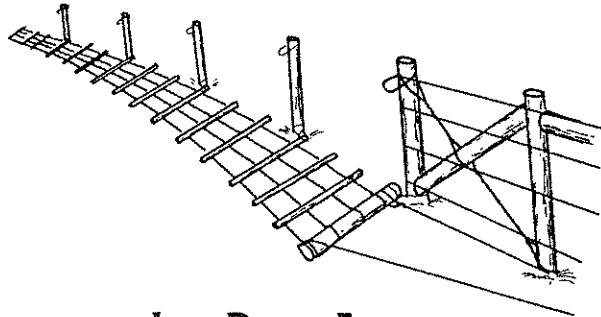

Lay-Down Fences

During times of heavy snow accumulation in unused pastures, you can do yourself and all big game a favor by employing a swing-back section of fence, or possibly a segment of lay-down or adjustable fence or a pass structure, as shown above. The lay-down not only allows game to travel, it keeps your fence section intact through snows that might otherwise cause serious problems.

LAY-DOWN FENCE

not to scale

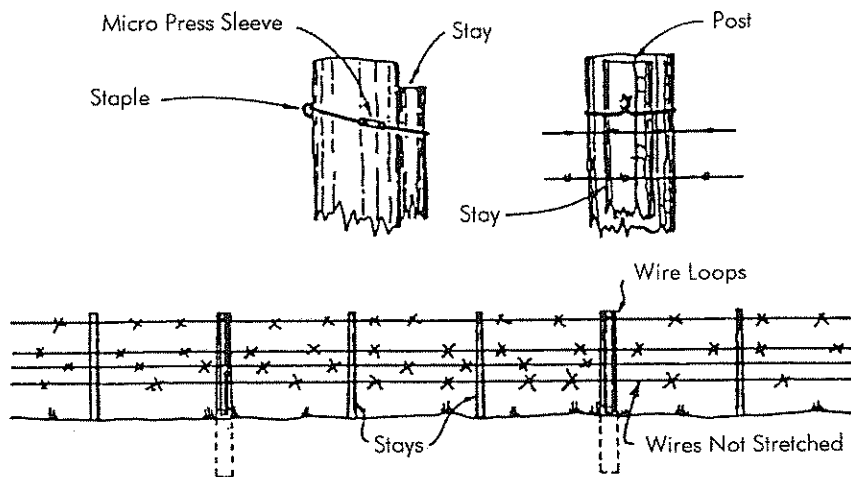

High-tensile Wire Fencing

High tensile can be a low maintenance alternative minimizing your annual fencing repairs. The CDOW recommends barbless top and bottom wires and barbed in the middle.

Check list:

- Bottom wire at least 16" above the ground.
- At least 12" between top two wires.
- Top wire 40" or lower.
- Flag newly constructed portions of fence.

SMOOTH WIRE FENCE (HIGH TENSILE)

not to scale

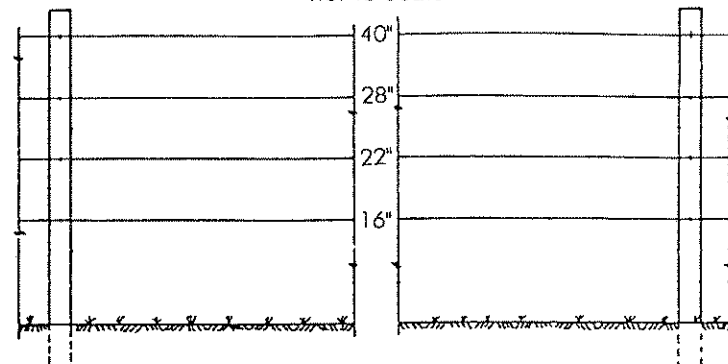

Vinyl Coated Wire

The increased visibility of the wire helps elk and deer judge their jump better and either clear it or use another location to cross. It is recommended that this replaces the top wire in a fence and the color should be white. The vinyl coating comes in several sizes, ranging from 3/16" to 6". The internal wire should be high-tensile wire. It has been found vinyl wire will dramatically reduce damage to fences of all heights.

TYPICAL POST & POLE FENCE

not to scale

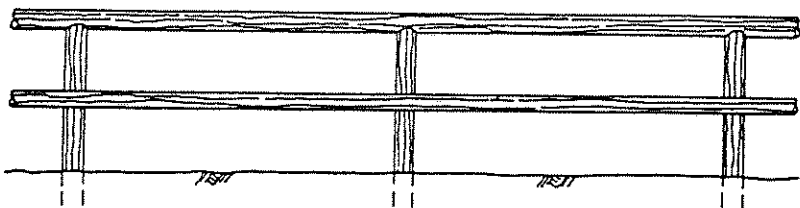

POST, POLE, & WIRE FENCE

not to scale

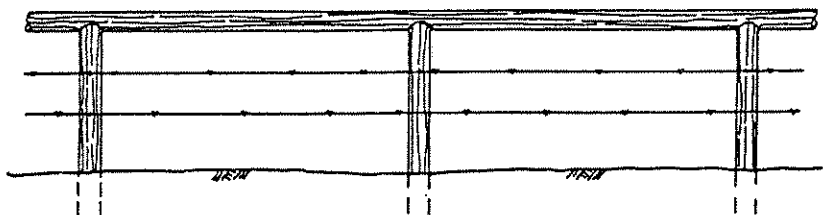

Rail Fencing

Rail fencing presents unique problems for migrating elk and deer. Fawns and calves have significant problems crossing these fences because they can't jump high enough, and cannot fit through or under them. In winter conditions, snow can build up on the top rail, creating an artificial barrier that will deter elk and deer from crossing. To prevent this, the CDOW recommends that rail fences be constructed of three rails or fewer. All rails must be the rounded log-type (not a flat 2" x 10" or a split rail - where snow builds up easily). The fence should not be over 48" tall with spacing between each rail 16" for the younger animals to pass through. 2" x10" planks or 2" x12" planks are unacceptable because they visually create a barrier.

BUCK & POLE FENCE

not to scale

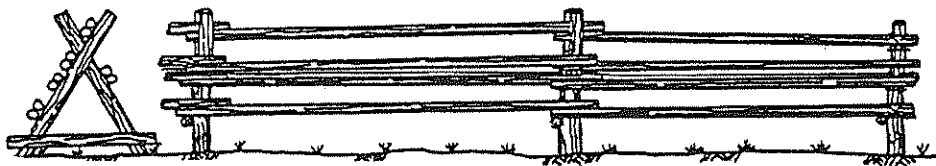

TYPICAL SUSPENSION FENCE

not to scale

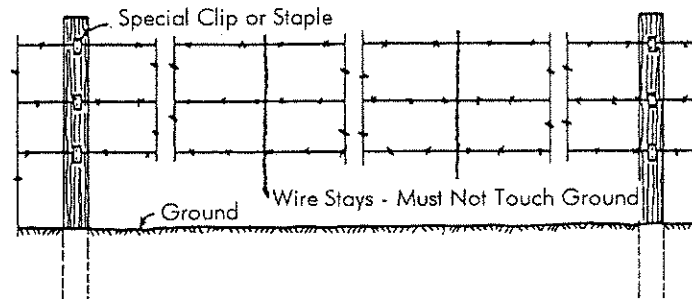

FASTENING MECHANISMS for Adjustable Wire Fence

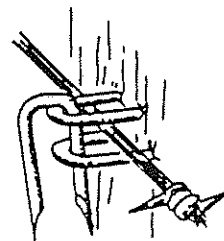

STAPLE LOCK - Simple and effective on wood posts. Holds wire tight if standard fence staples are used.

HOOK - Made from large square - end staple. Quite adequate for bottom hook but difficult to drive into untreated portion of post. Use in conjunction with staple lock or metal clip.

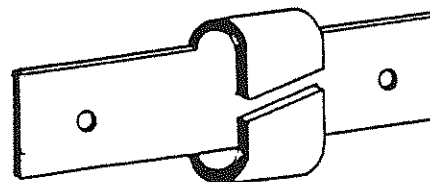
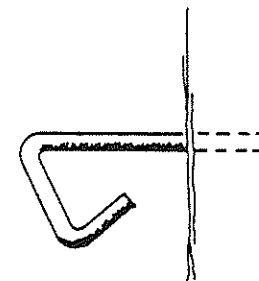

METAL CLIP - Excellent on either wood or steel posts. Easy to install, no maintenance and allows fastest wire adjustment. Existing fences easy to modify with this clip.

Wire Cattle Fences

For three-strand wire fences, the CDOW recommends that the top wire be a 12 ½ gauge twisted, barbless type at a maximum height of 42". It is critical that the middle wire, which can be barbed, be located a minimum of 12" below the top wire for kick space, to prevent entanglement when elk and deer jump over it. Keep top wire tight - a loose top wire can cause an elk or deer's leg to become twisted with the next wire. The bottom wire should be 16" above the ground.

Checklist:

- Smooth bottom wire at least 16" above the ground.
- At least 12" between top two wires.
- Top wire 42" or lower.
- Use stays every 6' to 8'.
- Flag newly constructed portions of fence.

TYPICAL 3 AND 4 STRAND CATTLE FENCE

Use Recommended Wire Fasteners

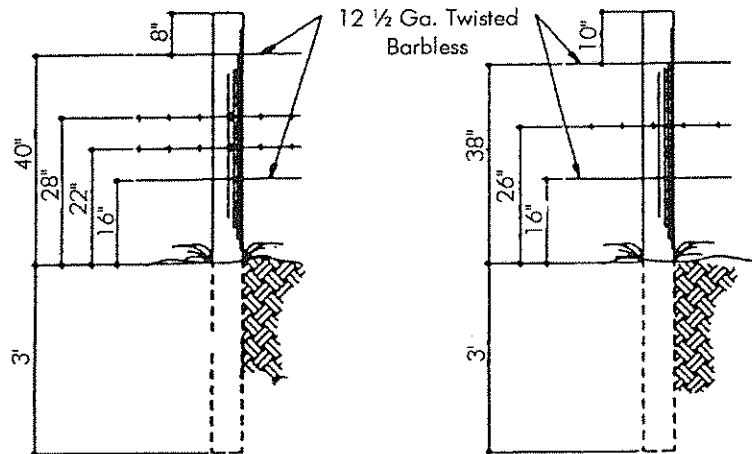

ADJUSTABLE FOUR-STRAND FENCE

not to scale

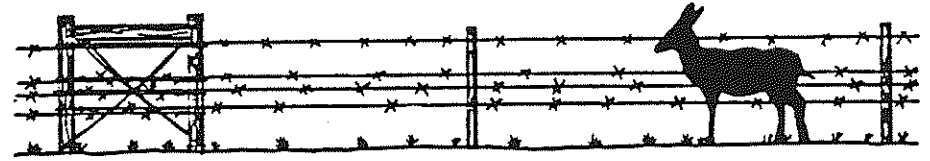

Standard Configuration

Adjustable Wire Fences

Adjustable wire fences have specially made clips attached to the posts that enable the wires to be lowered during times of wildlife migration. Raising or lowering one or more wires can be the most successful and efficient fence modification for elk and deer passage during periods when livestock are not present. The primary objective of wire adjustment is to reduce an elk or deer's dependency on its hind legs for jumping. As the wire height approaches the length of a deer's legs (approximately 20"), this dependency on their hind legs nears zero.

Lowering the top wire of a 42" fence by 17" and the second wire 5" reduces barrier height to about 25". This height can be negotiable by elk and deer under virtually all conditions. This type of fencing has the added benefit of not being damaged by wildlife crossings.

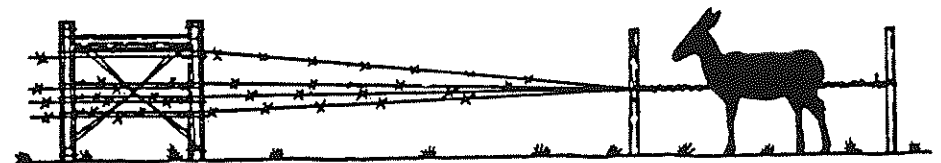

Modification Allowing Nearly Free Movement